

# MICROTECH LT-8 4 CYL SEQUENTIAL ENGINE MANAGEMENT SYSTEM

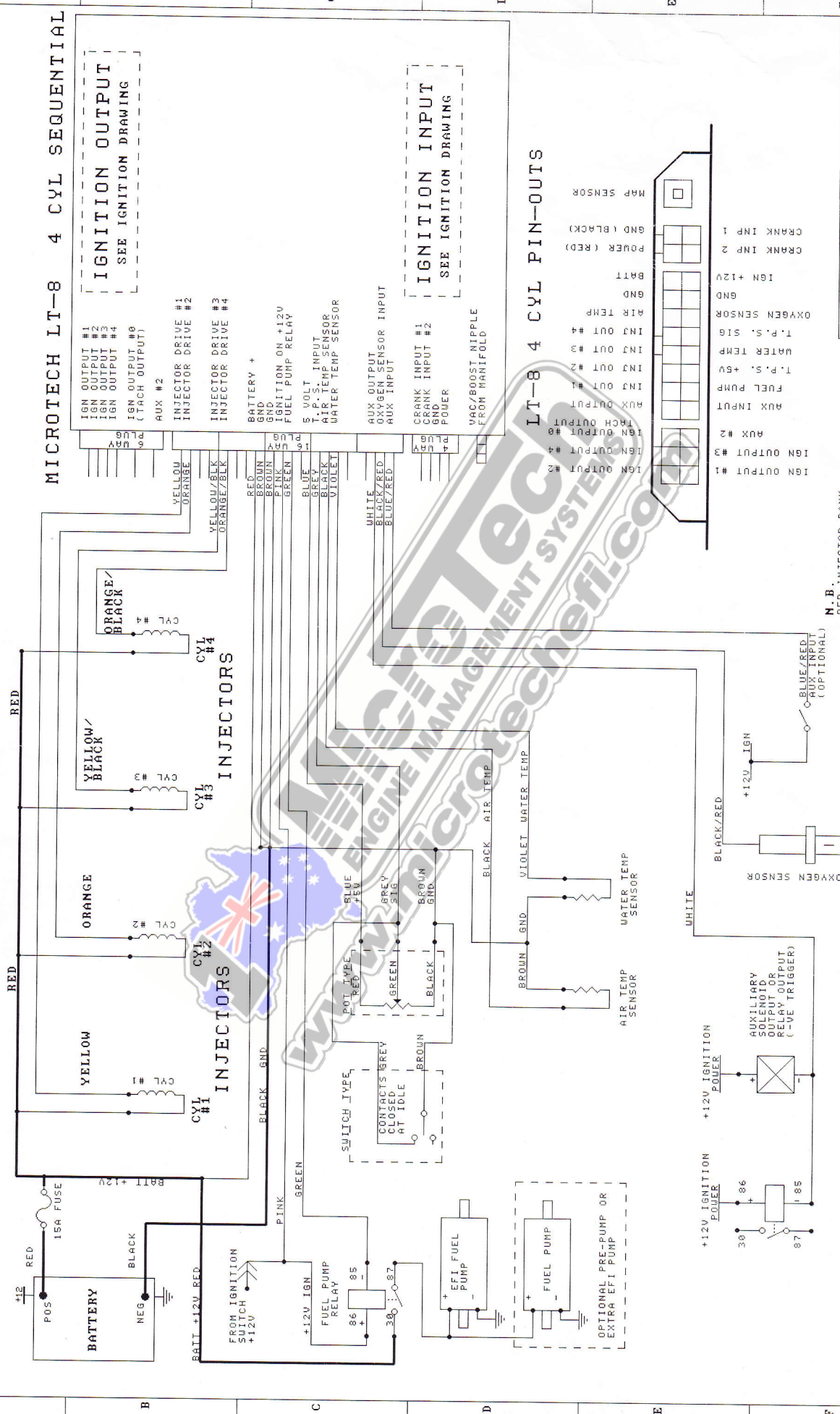

**Title**  
LT-8 4 DIRECT FIRE

Size	Number	Revision
A3	4	1.0

Date: 4-OCT 2004  
Sheet 1 of 2  
File: LTR8.4/1  
Drawn By: DDM

**N.B.**  
PER INJECTOR BANK  
USE ONLY -  
1 X 2 OHM INJECTORS  
2 X 2 OHM INJECTORS  
2 X 12 OHM INJECTORS  
4 X 12 OHM INJECTORS

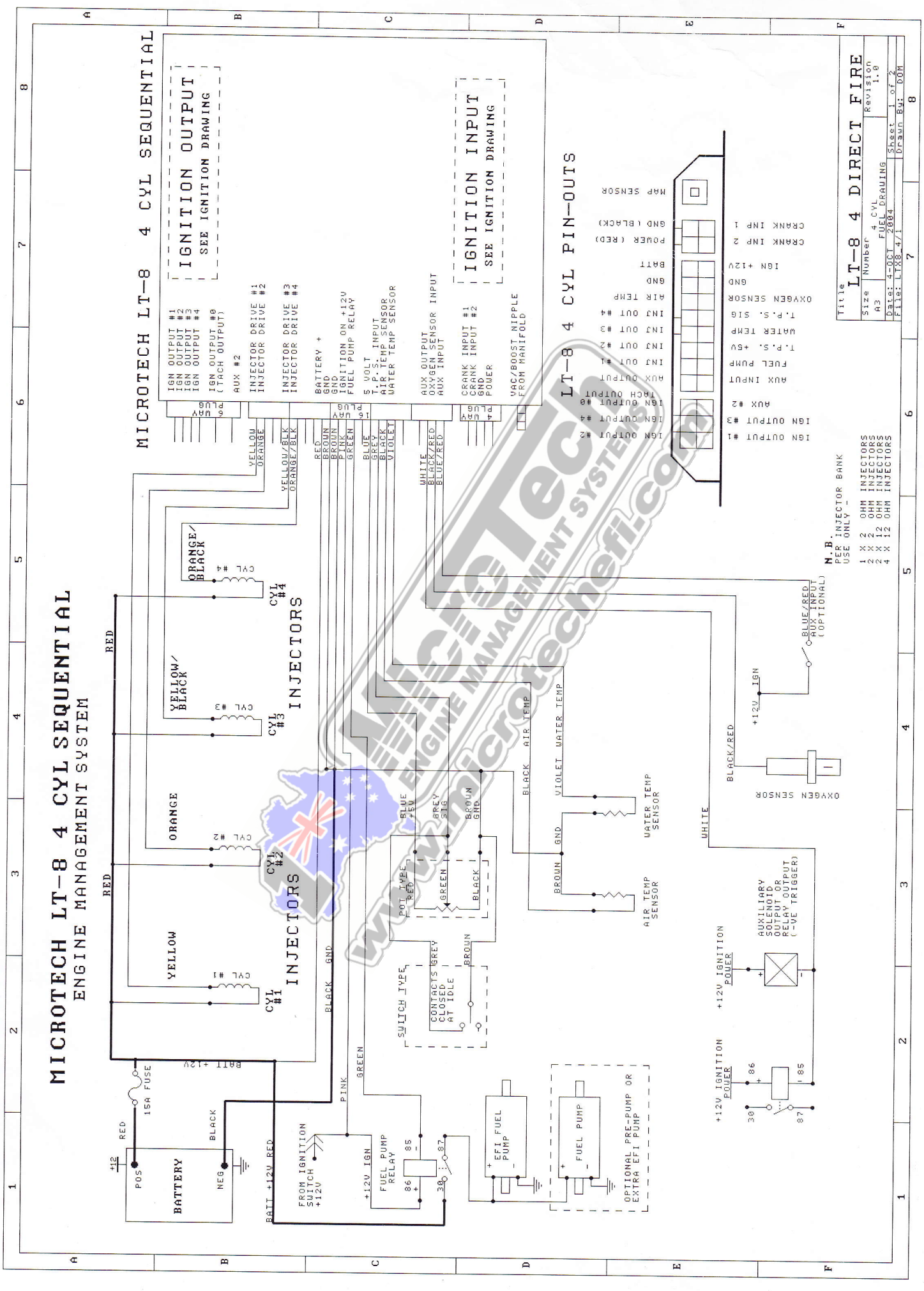

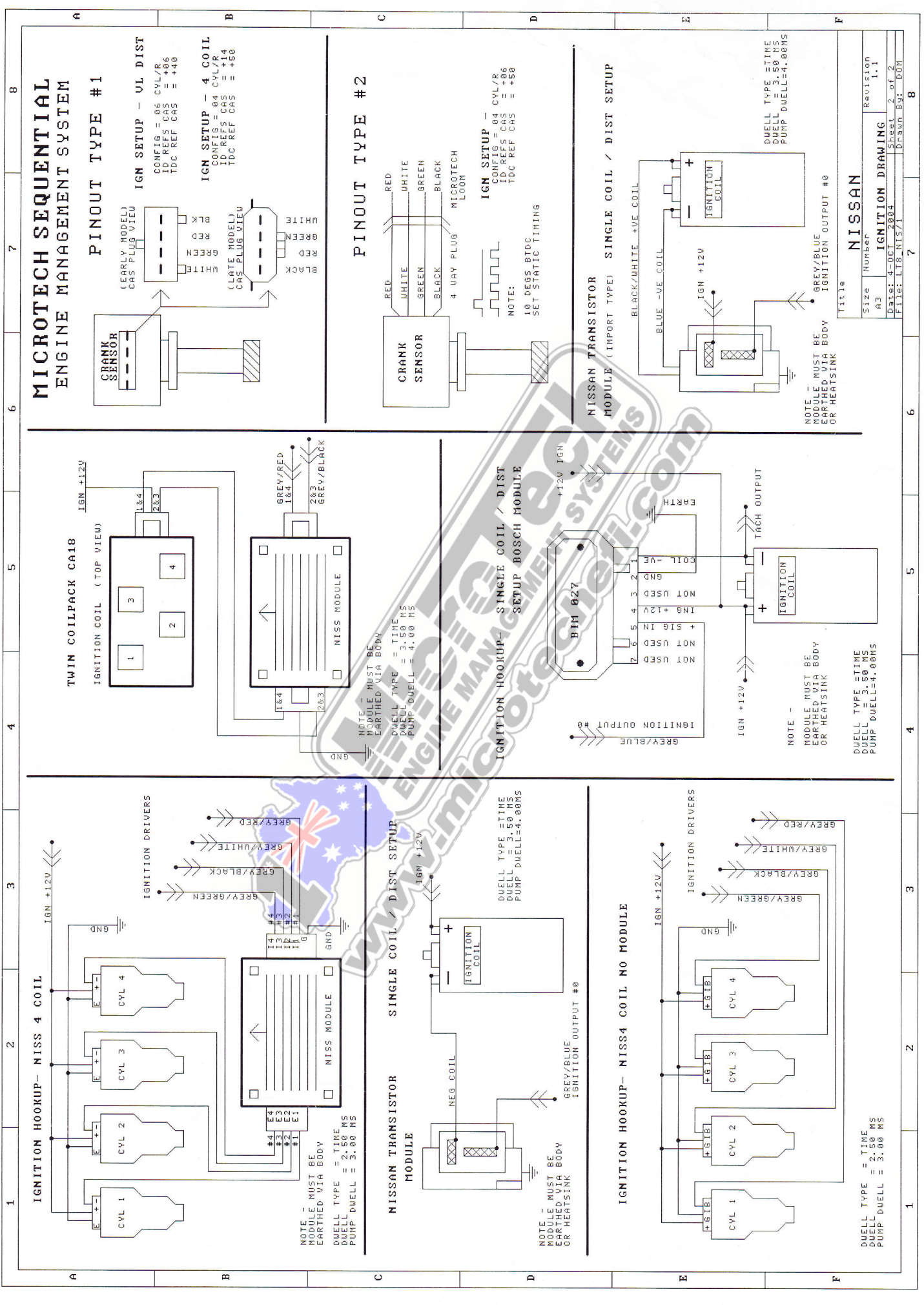

# MICROTECH SEQUENTIAL ENGINE MANAGEMENT SYSTEM

## PINOUT TYPE #1

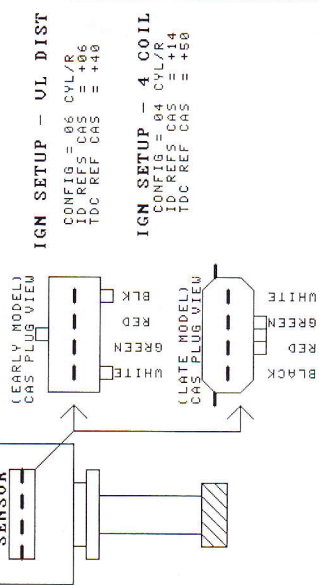

## PINOUT TYPE #2

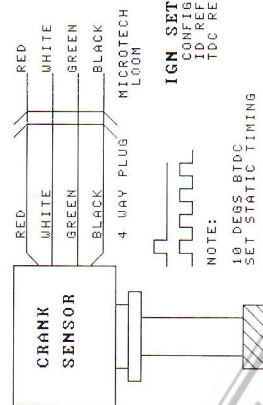

## NISSAN TRANSISTOR MODULE (IMPORT TYPE) SINGLE COIL / DIST SETUP

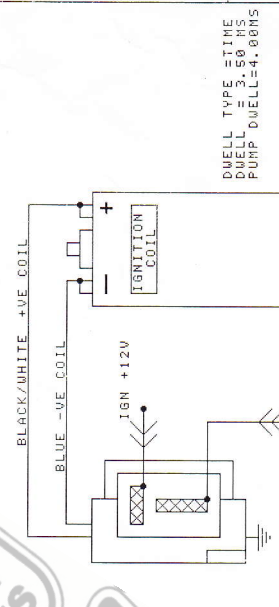

## TWIN COILPACK CA18

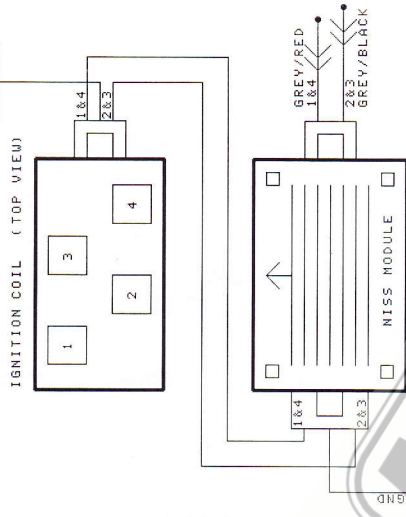

## IGNITION HOOKUP - SINGLE COIL / DIST SETUP BOSCH MODULE

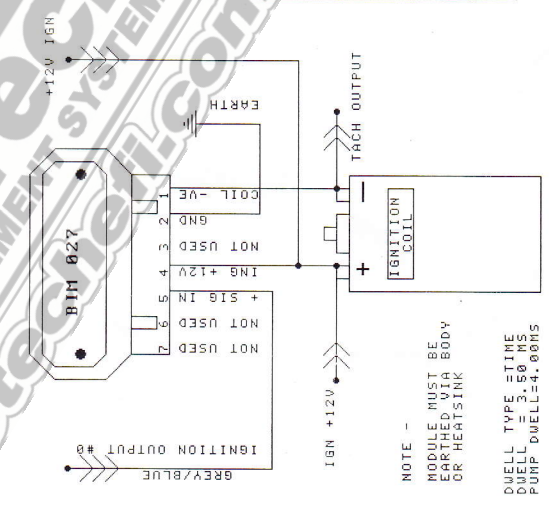

## IGNITION HOOKUP - NISS 4 COIL

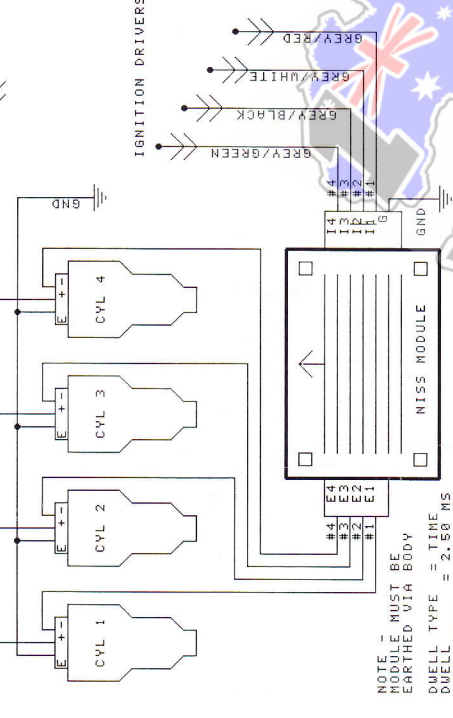

## NISSAN TRANSISTOR MODULE

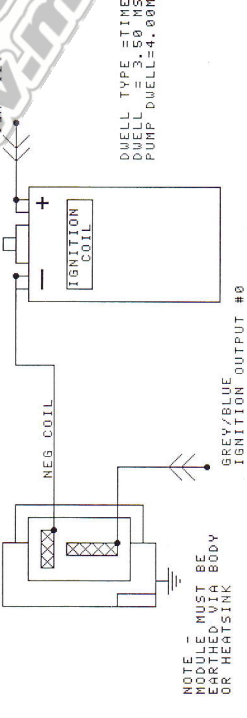

## IGNITION HOOKUP - NISS4 COIL NO MODULE

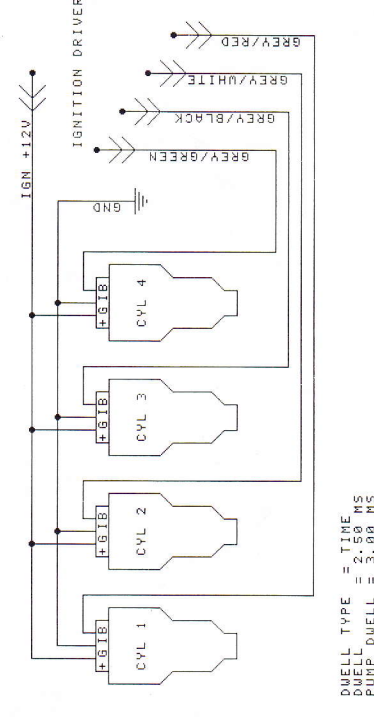

**NISSAN**

Size	Number	Revision
A3	IGNITION DRAWING	1.1
Date:	4-OCT-2004	Sheet 2 of 2
File:	LTS-NIS71	Drawn By: DOR